

THE PROPERTY OF THE DRAWING IS ESTABLISHED BY LAW. IT IS FORBIDDEN TO PRODUCE OR SHOW IT TO THIRD PART. WITHOUT A WRITTEN AGREEMENT.

Item	Name	Q.ty
1	R.6.SCH	1
2	V.TCE6x35	1
3	WKA.30.30.140	1

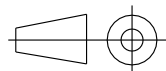
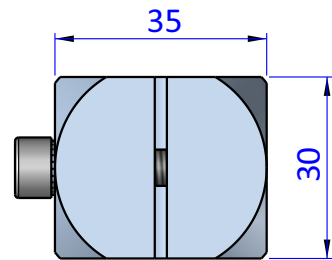
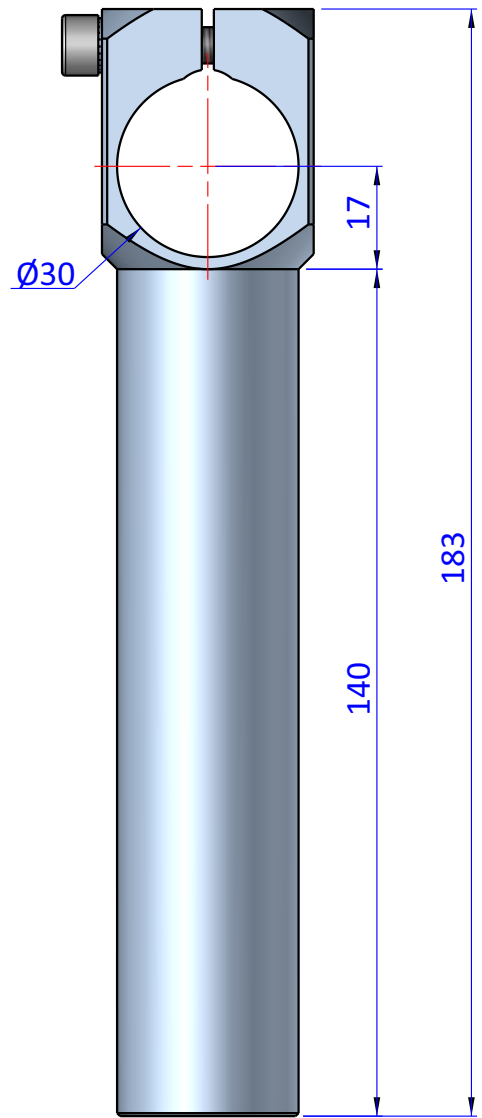
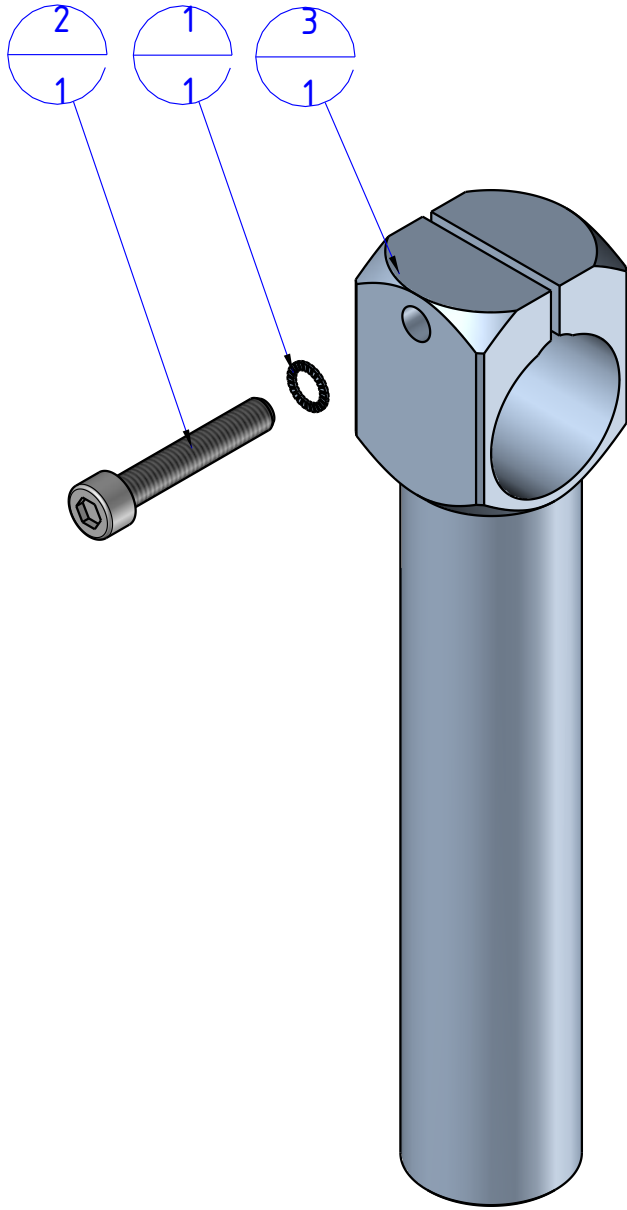

DESIGNED FROM		REVIEW
FPS Automation		A
DATE	WEIGHT	
25/09/2020	0,241kg	
CODE		
CA.WKA.30.30.140		

Format A4

UNI 936-76

GENERAL TOLERANCE

UNI - ISO 2768

CLASSE f

DESCRIPTION

CA.WKA.30.30.140